



MATH ASSESSMENT PROGRAM

5TH
GRADE







New York State
EDUCATION DEPARTMENT
Knowledge > Skill > Opportunity

New York State Testing Program
Grade 5
Mathematics Test

Released Questions

2023

New York State administered the Mathematics Tests in May 2023 and is making approximately 75% of the questions from these tests available for review and use.



New York State Testing Program

Grades 3–8 Mathematics

Released Questions from 2023 Exams

Background

As in past years, SED is releasing large portions of the 2023 NYS Grades 3–8 English Language Arts and Mathematics test materials for review, discussion, and use.

For 2023, included in these released materials are at least 75 percent of the test questions that appeared on the 2023 tests (including all constructed-response questions) that counted toward students' scores. Additionally, SED is also providing a map that details what each released question measures and the correct response to each question. These released materials will help students, families, educators, and the public better understand the tests and the New York State Education Department's expectations for students.

Understanding Math Questions

Multiple-Choice Questions

Multiple-choice questions are designed to assess the New York State P–12 Next Generation Learning Standards for Mathematics. Mathematics multiple-choice questions will be used mainly to assess standard algorithms and conceptual standards. Multiple-choice questions incorporate both the grade-level standards and the “Standards for Mathematical Practices.” Many questions are framed within the context of real-world applications or require students to complete multiple steps. Likewise, many of these questions are linked to more than one standard, drawing on the simultaneous application of multiple skills and concepts.

One-Credit Constructed-Response Questions

One-credit constructed-response questions require students to complete a task and provide only their final answer. These one-credit questions will often require multiple steps, assessing procedural skills, as well as conceptual understanding and application. While students may show how they arrived at their final answer, only the final answer will be scored.

Two-Credit Constructed-Response Questions

Two-credit constructed-response questions require students to complete tasks and show their work. These two-credit response questions will often require multiple steps, the application of multiple mathematics skills, and real-world applications. Many of the short-response questions will cover conceptual and application standards.

Three-Credit Constructed-Response Questions

Three-credit constructed-response questions ask students to show their work in completing two or more tasks or a more extensive problem. These three-credit response questions allow students to show their understanding of mathematical procedures, conceptual understanding, and application. Three-credit response questions may also assess student reasoning and the ability to critique the arguments of others. The scoring rubric for all constructed-response questions can be found in the grade-level Educator Guides at <http://www.nysed.gov/state-assessment/grades-3-8-ela-and-math-test-manuals>.

New York State P–12 Next Generation Learning Standards Alignment

The alignment(s) to the New York State P–12 Next Generation Learning Standards for Mathematics is/are intended to identify the primary analytic skills necessary to successfully answer each question. However, some questions measure proficiencies described in multiple standards, including a balanced combination of procedure and conceptual understanding. For example, two-credit and three-credit constructed-response questions require students to show an understanding of mathematical procedures, concepts, and applications.

These Released Questions Do Not Comprise a “Mini Test”

To ensure it is possible to develop future tests, some content must remain secure. This document is *not* intended to be representative of the entire test, to show how operational tests look, or to provide information about how teachers should administer the test; rather, its purpose is to provide an overview of how the test reflects the demands of the New York State P–12 Next Generation Learning Standards.

The released questions do not represent the full spectrum of the standards assessed on the State tests, nor do they represent the full spectrum of how the standards should be taught and assessed in the classroom. It should not be assumed that a particular standard will be measured by an identical question in future assessments.

Name: _____



New York State Testing Program

2023 Mathematics Test Session 1

Grade 5

May 2–4, 2023

RELEASED QUESTIONS

Developed and published under contract with the New York State Education Department by Questar Assessment Inc., 14720 Energy Way, Apple Valley, MN 55124. Copyright © 2023 by the New York State Education Department.

Session 1

Session 1



TIPS FOR TAKING THE TEST

Here are some suggestions to help you do your best:

- Read each question carefully and think about the answer before making your choice.
- You have been provided with mathematics tools (a ruler and a protractor) and a reference sheet to use during the test. It is up to you to decide when each tool and the reference sheet will be helpful. You should use mathematics tools and the reference sheet whenever you think they will help you to answer the question.

1 There is $\frac{7}{8}$ of a whole pizza in Anthony's refrigerator. He eats $\frac{3}{8}$ of the whole pizza for lunch. What fraction of the whole pizza is left after Anthony eats pizza for lunch?

A $\frac{10}{8}$

B $\frac{5}{8}$

C $\frac{4}{8}$

D $\frac{3}{8}$

2 What number represents ninety-nine thousandths?

A 0.099

B 0.990

C 9.900

D 99.000

3 A shipping box in the shape of a right rectangular prism has a base with an area of 16 square feet and a height of 6 feet. What is the volume, in cubic feet, of the box?

A 22

B 96

C 192

D 1,536

GO ON

8 What number has the same value as 32×10^4 ?

- A 3.2
- B 320
- C 0.0032
- D 320,000

GO ON

- 9 Which model is shaded to represent the area of a rectangle that is $\frac{4}{5}$ centimeter long and $\frac{3}{10}$ centimeter wide?

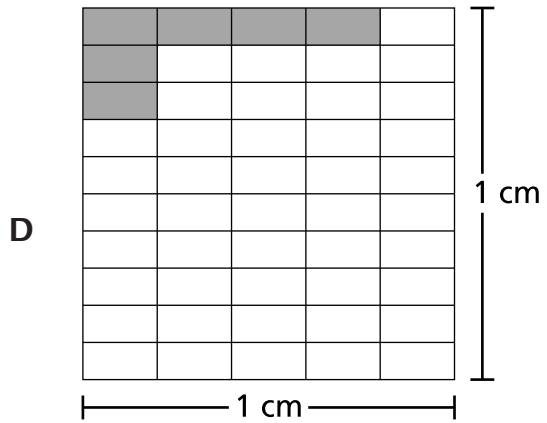
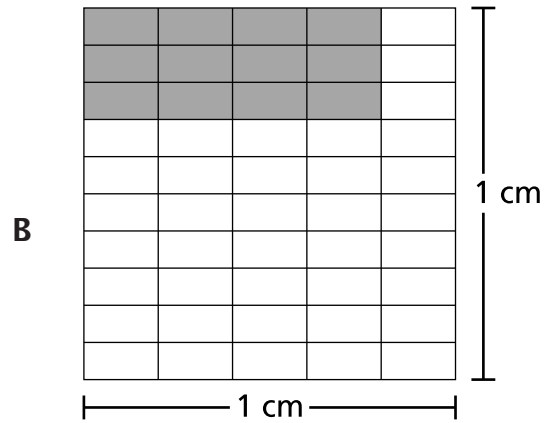
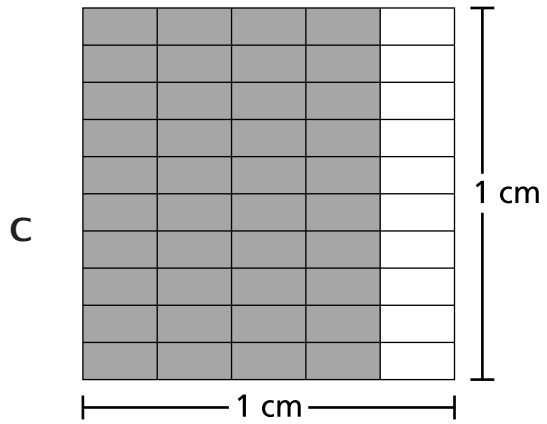
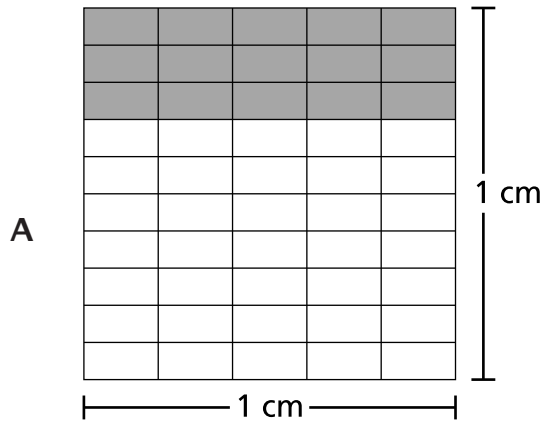

10 A mall parking lot has 2,232 parking spaces. There are 24 parking spaces in each row. How many rows are in the parking lot?

A 89

B 93

C 94

D 97

11 A teacher has 20 feet of string to use for a class project. She uses all of the string and gives an equal amount to 8 students. How much string, in feet, will each student get?

A $2\frac{1}{5}$

B $2\frac{3}{10}$

C $2\frac{1}{2}$

D $2\frac{3}{4}$

GO ON

14

What digit will be in the tens place after 8,642 is divided by 10 ?

A 2

B 4

C 6

D 8

GO ON

17 Which expression has a value less than $1\frac{1}{2}$?

A $1\frac{1}{2} \times \frac{3}{2}$

B $1\frac{1}{2} \times \frac{1}{2}$

C $1\frac{1}{2} \times 2$

D $1\frac{1}{2} \times 1$

18 A diagram of two right rectangular prisms, each made with unit cubes, is shown below.

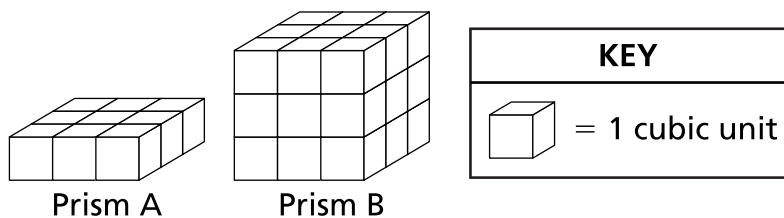

What is the total volume, in cubic units, of Prism A and Prism B ?

A 9

B 18

C 27

D 36

20

The total snowfall for a town from Friday through Sunday was 34 inches.

- On Friday, the snowfall was 11.25 inches.
- On Saturday, the snowfall was 9.9 inches.

How many inches of snow fell on Sunday?

- A 12.85
- B 13.15
- C 20.34
- D 21.15

21

Dorian walks at an average speed of $2\frac{1}{2}$ miles per hour. He walks for $\frac{3}{4}$ hour. How many miles does he walk?

- A $1\frac{3}{4}$
- B $1\frac{7}{8}$
- C $2\frac{3}{8}$
- D $3\frac{1}{4}$

GO ON

26

Ms. Roman buys 3.5 pounds of birdseed. She pays \$4.28 per pound. How much did Ms. Roman pay for all of the birdseed?

- A \$4.28
- B \$7.78
- C \$12.84
- D \$14.98

GO ON

29

A store sells packages of black pens, blue pens, and red pens.

- $\frac{4}{9}$ of the packages are black pens
- $\frac{1}{6}$ of the packages are blue pens

What fraction of the packages are red pens?

- A $\frac{5}{15}$
- B $\frac{7}{18}$
- C $\frac{10}{15}$
- D $\frac{11}{18}$

STOP

Grade 5
2023
Mathematics Test
Session 1
May 2–4, 2023

Name: _____



New York State Testing Program

2023 Mathematics Test Session 2

Grade 5

May 2–4, 2023

RELEASED QUESTIONS

Developed and published under contract with the New York State Education Department by Questar Assessment Inc., 14720 Energy Way, Apple Valley, MN 55124. Copyright © 2023 by the New York State Education Department.

Session 2



TIPS FOR TAKING THE TEST

Here are some suggestions to help you do your best:

- Read each question carefully and think about the answer before making your choice or writing your response.
- You have been provided with mathematics tools (a ruler and a protractor) and a reference sheet to use during the test. It is up to you to decide when each tool and the reference sheet will be helpful. You should use mathematics tools and the reference sheet whenever you think they will help you to answer the question.
- Be sure to show your work when asked.

31

A diagram of a right rectangular prism made of unit cubes is shown below.

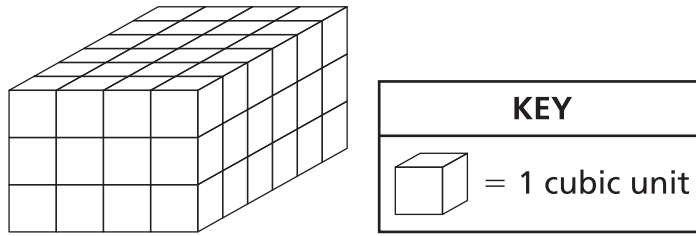

What is the volume, in cubic units, of the right rectangular prism?

- A 13
- B 24
- C 60
- D 72

32

There are 210 apples placed equally into 14 boxes. How many apples are in each box?

- A 12
- B 14
- C 15
- D 21

GO ON

33 Diane walks $3\frac{3}{8}$ miles on Saturday. She walks $1\frac{5}{6}$ fewer miles on Sunday than she does on Saturday. How many miles does Diane walk on Sunday?

A $1\frac{13}{24}$

B $2\frac{11}{24}$

C $2\frac{13}{24}$

D $5\frac{5}{24}$

34 Which statement about a rhombus and a square is always true?

A Both shapes are parallelograms that have four equal sides.

B Both shapes are parallelograms that have four right angles.

C Both shapes are quadrilaterals with exactly two acute angles.

D Both shapes are quadrilaterals with exactly one pair of parallel sides.

35 A cook in a restaurant has 13 gallons of milk. How much milk, in quarts, does the cook have?

A 17

B 26

C 42

D 52

36

This question is worth 1 credit.

The heights, in inches, of four towers made from toothpicks are shown below.

- 33.1
- 33.2
- 29.3
- 33.3

Write a number sentence comparing the heights, in inches, of the two tallest towers. Be sure to include the symbol $>$, $<$, or $=$ in your answer.

Answer _____

GO ON

37

This question is worth 1 credit.

Andre is using a 15-foot piece of ribbon for an art project. He cuts the ribbon into equal-sized pieces $\frac{1}{3}$ foot in length. Using all of the ribbon, how many pieces of ribbon does Andre cut?

Answer _____ pieces

GO ON

38

This question is worth 1 credit.

What is the volume, in cubic inches, of the cube shown in the diagram below?

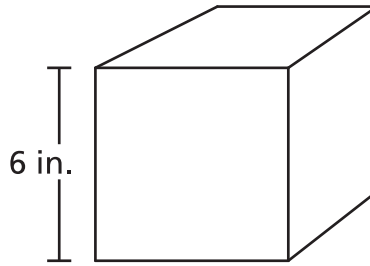

Answer _____ cubic inches

GO ON

39

This question is worth 2 credits.

Josiah makes a total of 195 ounces of lemonade. He pours the lemonade into 16-ounce bottles until each bottle is full. What is the greatest number of bottles Josiah can fill completely with the lemonade?

Show your work.

Answer _____ bottles

GO ON

40

This question is worth 2 credits.

A multiplication problem is shown below.

$$42 \times \frac{5}{8}$$

A student claims that the product will be greater than 42. Is the student's claim correct? Explain without calculating the product.

Explain how you know your answer is correct.

GO ON

41

This question is worth 2 credits.

A diagram of a 3-dimensional figure is shown below.

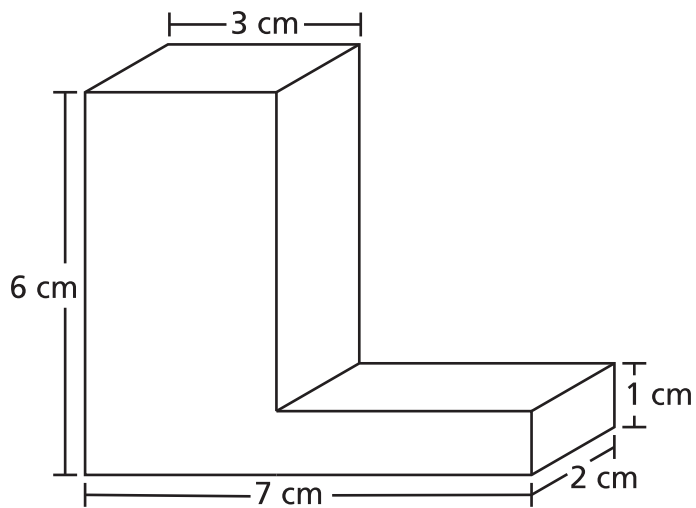

What is the volume, in cubic centimeters, of the figure?

Show your work.

Answer _____ cubic centimeters

GO ON

42

This question is worth 2 credits.

A student writes 67.203 in expanded form as shown below.

$$(6 \times 10) + (7 \times 1) + \left(2 \times \frac{1}{10}\right) + \left(3 \times \frac{1}{100}\right)$$

The student made an error. Where did the student make an error? As part of your answer, write the number in the correct expanded form.

Explain your answer.

GO ON

43

This question is worth 2 credits.

Adam opens a $\frac{1}{2}$ -pound can of tuna. He uses all the tuna to feed his cats. He puts an equal amount of tuna in 4 containers for his cats. How much tuna, in pounds, is in each container?

Show your work.

Answer _____ pound(s)

GO ON

44

This question is worth 3 credits.

The line plot below shows the recorded amount of rain that fell in a city during the month of April.

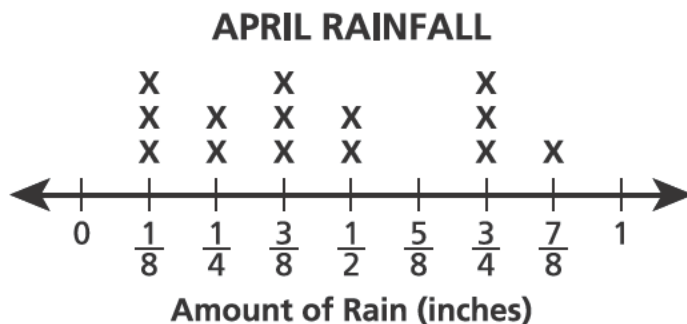

What was the total amount of rain, in inches, recorded in April?

Show your work.

Answer _____ inches

The total amount of rain that fell in the city during the month of August was $8\frac{1}{4}$ inches.

What was the difference in total rainfall, in inches, between August and April?

Show your work.

Answer _____ inches

STOP

Grade 5
2023
Mathematics Test
Session 2
May 2–4, 2023



STERLING



WE
GOT
NOW



MANE



WE
GOT
NOW



SAKA



WE
GOT
NOW

